

2024 TIRT Autonomous Vehicle Maker Challenge

Competition Rules for Elementary School Student Group

Competition Regulations

2024.06.28

A. Origins of the Project :

ShaYangYe is committed to advancing robotics education and promoting industry collaboration, with the aim of establishing Taiwan as an international stage for robotics competitions. Since 2018, we have collaborated with the Taoyuan City Government to organize the INTERNATIONAL ROBOTIC FESTIVAL IN TAOYUAN for six consecutive years. This pioneering event brings together four major robotics competition fields: land, sea, air, and maker. Over the past six years, it has attracted over 12 million participants both online and offline, with teams from 20 countries participating and a total of 9,400 teams from domestic and international regions. Our goal is to connect robot training and competitions with relevant industries, expand the international perspectives of Taiwanese participants, and create a cross-domain international robotics extravaganza that shines in Taoyuan and the world! For the 2024 INTERNATIONAL ROBOTIC FESTIVAL IN TAOYUAN, in order to promote Taiwan's robotics industry and self-made brands, we are planning a series of events, including the TIRT Autonomous Vehicle Racing Competition. This competition combines diverse control systems to showcase Taiwan's technological prowess in intelligent manufacturing. Furthermore, it serves as a link to the TIRT International Competition and Conference!

B. Objectives of the Project :

1. By organizing competition activities and facilitating learning exchanges, we aim to provide domestic and international teams with opportunities to observe and learn about programming, mechatronics integration, and knowledge sharing, thereby inspiring students' motivation to learn.
2. By incorporating diverse open control systems, we plan to design different competition targets that foster the development of students' creativity, design skills, integration abilities, and programming capabilities.

C. Guiding Organization :

Taoyuan City Government, Taoyuan City Council

D. Host Organization :

Department of Economic Development, Taoyuan

E. Executing Unit :

SHAYANGYE Cultural & Educational Foundation

F. Eligible Participants :

1. Students from elementary schools in all counties and cities nationwide.
2. International teams of the same age are also welcome to participate (proof of valid enrollment in their respective countries is required).
3. Participants must have a valid student status recognized by the Ministry of Education.

G. Competition events :

Autonomous Vehicle Maker Challenge



TIRT Official website.

H. Competition grouping :

Elementary School Division: Limited to students from public elementary schools, with a maximum of 3 participants per team.

I. Event description and schedule planning :

1. Registration Method : Visit the TIRT official website (<https://www.tirtpointsrace.org/>)
2. Registration Period : From May 30, 2024, to October 28, 2024 (subject to adjustment based on team registration status).
3. Competition schedule : November 10, 2024 (Sunday).
4. Competition location : The Taoyuan Arena (No. 1, Section 1, Sanmin Road, Taoyuan District). Please refer to the official website for any updates or changes.

J. Other matters :

The organizer reserves the right to modify the regulations and rules of the event. For any other matters not mentioned, please refer to the latest announcements on the official competition website as the authoritative source. If you have any concerns regarding this project, please contact the organizer directly at the following phone numbers: 03-3623452 ext. 5338 (Ms. Chin) or ext. 5310 (Mr. Wang).

2024 TIRT Autonomous Vehicle Maker Challenge

Competition Rules for Elementary School Student Group

2024.06.28

A. Competition qualification :

The competition is open to elementary school teams participating in the Elementary School Division. It is a cross-grade competition, and participants' eligibility will be verified by the organizer. If a team is found to be ineligible for the competition, the organizer reserves the right to revoke any awards and take appropriate legal actions against the team.

B. Competition Format :

1. The vehicle must walk automatically following the track. This competition is a speed contest.
2. Line tracking is defined as the vehicle's main body, in its projection, covering the guiding line (white line) on the track, excluding dashed and shortcut sections.
3. The direction of travel must align with the guiding line (white line).
4. Failure to adhere to the line tracking definition will result in disqualification.
5. The order of appearance will be determined by a draw.
6. Each participating team will have two opportunities to achieve results on the track during the competition. The best result will be considered for scoring, as announced by the judges on the competition day. Depending on the on-site registration situation, the number of attempts and the opportunity to modify the program may be increased.
7. The completion time of the participating teams takes precedence in ranking. If the number of teams that successfully complete the race (from the starting point to the finish line) is less than the number of winning teams, the team with the farthest distance traveled will be selected to fill the remaining spots. If no team completes the race, the ranking will be based on the distance traveled by each team. If teams have similar distances, the judges will announce a rematch (the rematch rules will be the same as the formal competition).

C. . Vehicle regulations :

1. The vehicle should be wheeled. It should have two drive shafts at most and a random number of auxiliary wheels.
2. The main structure of the assembled vehicle must be made of plastic building blocks. The use of metal materials is allowed for structural connections.
3. The total length (including wheels) of the assembled vehicle in a stationary state should be less than 20cm. The total width (including wheels) should be less than 15cm. The total height should be less than 15cm.
4. The participating devices must obtain energy through self-carried battery power.
5. There are no restrictions on the platform system of the main controller, but each vehicle is limited to using only one main controller.

D. Competition Rules :

1. Competition Regulations :



- a. All participants must complete the registration and check-in process. The race order will be determined through a draw, and teams must wait at the designated area according to the draw order. Once the vehicle has been checked and inspected, it must remain in the designated area throughout the competition and cannot be retrieved or adjusted during the race.
- b. The competition vehicles must be started using hardware switches and cannot be activated through external connections to avoid suspicions of modifying the vehicle's program.
- c. The competition order will be instructed by the relevant referees. Teams should enter the competition area in sequence. Only one team is allowed to compete on each track at a given time.
- d. After the referees call out the team's name, one designated team member can bring the self-driving car into the competition area. When the referee announces the start of the race, the participant must place the self-driving car in the starting zone, ensuring that no part of the car crosses the timing start line.
- e. Once the competition car is placed in the starting zone, the participant has one minute to make hardware adjustments and battery replacements.
- f. The competition car must follow the specified track route and complete various challenge tasks along the way. The automatic timing will be done by the timing start line sensor, and the completion of the challenge tasks will be determined by the referees. After the referees confirm and record the results, with the participant's signature for confirmation, the participant can retrieve the vehicle and place it in the designated area, waiting for the announcement of the results.
- g. In the event of disputes that cannot be resolved by the regulations, the decisions made by the referee panel will be final, and no objections will be allowed.

2. Disqualification determination:

If any of the following situations occur during the competition, it will result in disqualification. If the referee determines that the team has been disqualified, their finishing results will not be counted.

- a. Interfering with the competition vehicle or modifying the robot's program without permission from the referees, from the completion of the registration process until the end of the race.
- b. Engaging in behavior that disrupts the performance of other vehicles during the competition or any other violations of the regulations.
- c. Any actions by team members or related individuals, such as the team coach, that are deemed by the competition referees to severely impact other participating teams.
- d. Causing damage or significant contamination to the competition venue.

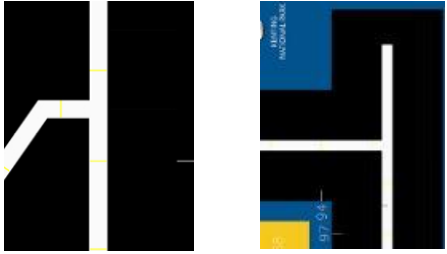
| Checkpoint Number and Name | Checkpoint Description | Diagram |
|---|---|--|
| <p>Start Point and Finish Line</p> | <p>When the vehicle crosses the starting line, the timer starts counting, and when the vehicle passes the finish line, the timer stops counting.</p> |  |
| <p>【A】 M-shaped Turn</p> | <p>Test the vehicle's ability to handle small turns. (Must follow the direction of the guide line, disqualification if crossing directly as shown in the upper right illustration) (Turn angle less than 60 degrees)</p> |  |
| <p>【B】 Circular Loop Line</p> | <p>When traveling along the circular track, driving on the left general lane or taking a shortcut on the right is allowed. The shortcut maneuver can only be performed after passing the starting point of the shortcut. (The shortcut starting line is for illustrative purposes only, and on the day of the competition, the judges will determine it based on the extension of the red and blue blocks intersection.) (Bend angle less than 60 degrees).</p> |  |

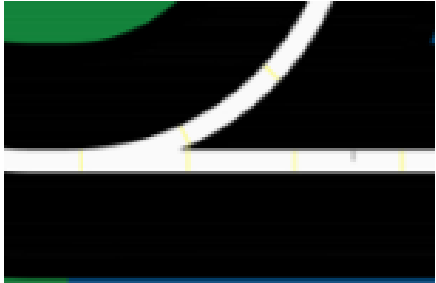
| Checkpoint Number and Name | Checkpoint Description | Diagram |
|---|---|--|
| <p>【C】 Decision at T-Intersection</p> | <p>When moving, follow the specified direction to make a right turn. If the vehicle makes a left turn at (2) contrary to the rules, but is able to automatically correct its route by making a U-turn, it can continue the competition.</p> |  <p>(1) (2)</p> |
| <p>【D】 Overpass Mechanism</p> | <p>A bridge with a slope of 30 degrees or less, testing the stability of the vehicle when going uphill or downhill.</p> |  |
| <p>【E】 Black and White Line Transition</p> | <p>Testing the vehicle's ability to handle black and white line transitions.</p> |  |
| <p>【F】 Fork Turn</p> | <p>Proceed according to the direction of the fork during movement, testing the vehicle's ability to handle forked turns.</p> |  |

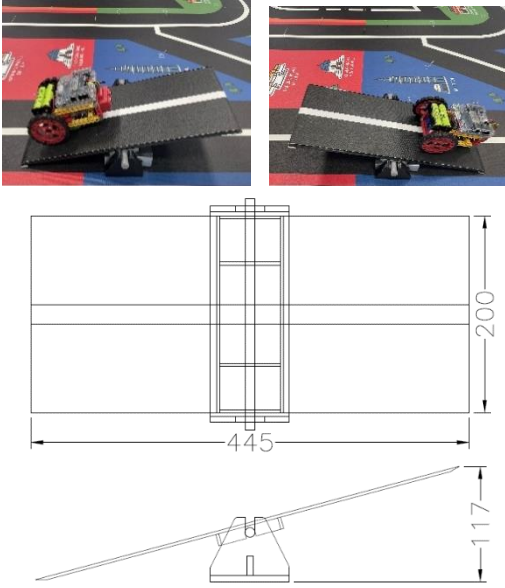
| Checkpoint Number and Name | Checkpoint Description | Diagram |
|--|--|--|
| <p style="text-align: center;">【G】 Seesaw Mechanism</p> | <p style="text-align: center;">A Fixed Point Seesaw Mechanism with an Incline Angle of 30 Degrees or Less. When the car reaches a certain height, the mechanism instantly transitions into a downhill slope.</p> |  |

F. Scoring Calculation and Failure Determination

1. Score Calculation

Complete one lap from the timing start line to the finish line and record the time. If unable to complete one lap within 180 seconds, the score will be calculated based on distance (the score recorded by the referee at the time of incomplete lap will be used, and no appeals will be accepted after the race).

a. Time Score Calculation :

- 1) Complete one lap from the timing start line to the finish line on the track within 180 seconds.
- 2) The recorded time shown on the timer will be used as the basis for the results.
- 3) In case of disputes that cannot be resolved by the regulations, the decision will be made by the judging panel, and no objections will be accepted.

b. Distance Score Calculation :

- 1) Distance Score Calculation Method: As determined by the referee panel, for self-driving cars that are unable to reach the finish line, the final position of the self-driving car's center point of the active wheel axle will be recorded based on the team number. In the event of a derailment, the center point of the active wheel axle at the moment of derailment will be recorded.





- 2) Derailed Definition: Determined by the referees from various angles, if any driving wheel of the self-driving car deviates from the black track and touches the colored map area, it is considered derailed (except when the angle of the curve is less than 60 degrees, as shown in the illustration on Page 6, Test Challenges - [A] T-shaped Turn [B] Circular Loop).
- 3) After the self-driving car leaves the starting area, if it loses power and remains stationary for 10 seconds during the course of the race, the distance score will be calculated.
- 4) If the self-driving car fails to reach the finish line within 180 seconds, the distance score will be calculated.
- 5) In case of collision with the designated obstacles, the distance score will be calculated.
- 6) In the event of disputes that cannot be resolved by the regulations, the decisions made by the judges will be final and not subject to appeal.

2. Failure Judgment

In the event of the following situations occurring during the competition, it will be considered a failure for that round, resulting in a disqualified outcome. The current round will be concluded, and the recorded score by the referee at that moment will be considered final, with no appeals permitted after the race.

- a. Failure to respond after three calls by the judging panel or inability of the participating team to enter the competition area results in disqualification for that round.
- b. Failure of the self-driving car to leave the starting zone within 10 seconds after the race begins.
- c. Failure to follow the direction of the guiding line results in disqualification for that round.

G. Prize for Winners

| Ranking | Bonus (NTD) | Certificate |
|---|----------------|-------------|
|  1st Prize | \$5,000 | V |
|  2nd Prize | \$3,000 | V |
|  3rd Prize | \$2,000 | V |
|  Excellent Work | - | V |